

SIEMENS

Ingenuity for life



Scan QR
code to know
more about
NXAirS 550+



Air-Insulated Compact Medium-Voltage Switchgear NXAirS 550+, up to 12kV

Catalog
HA 1797
Edition 2019

www.siemens.com/nxairs

Contents

Overview

Typical Applications

	Overview
2	Typical Applications
3	Features and Applications
3	Classification Description
	Technical Data
4	NXAirS 550+
4	3AE5 Vacuum Circuit-breaker
	Product Range
5	Circuit-breaker Panel
7	Disconnecting Panel
9	Bus Sectionalizer
11	Voltage Transformer Panel
12	Metering Panel
13	Self-used Transformer Panel
13	Symbol Description
	Design
14	Basic Design of Switchgear
15	Switchgear Design Introduction
16	Switchgear Compartment Introduction
17	Component Introduction
	Dimension & Layout Diagram
18	Foundation Dimension
18	Switchgear Assembling Layout
	Applicable Standards & Environment
19	Applicable Standards
19	Applicable Environment
19	Altitude Correction Factor Ka

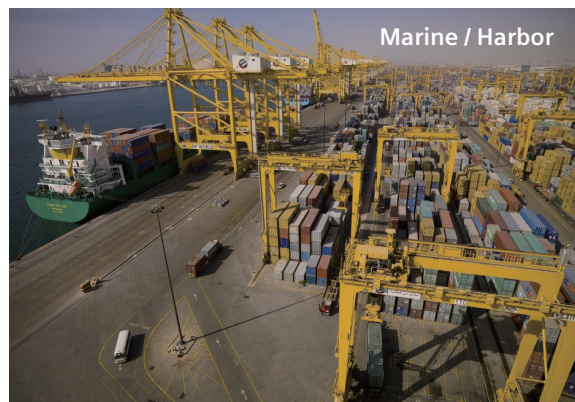

Features and Applications

Siemens medium-voltage air-insulated switchgear

The air-insulated switchgear follows the classic design of NXAirS and has the features of NXAirS standard switchgear. Its width is optimized to be 550mm, so as to provide more compact solution for the increasingly scarce space and reduce the construction investment expenses due to the reduced space requirement.

Siemens NXAirS air-insulated switchgear comprises busbar, switching device, connection, low-voltage compartment. The switchgear's frame and compartments are metallic enclosed. Shutters and partitions are earthed. Each compartment is metal-clad in pressure resistant design to increase the operator's safety.

Features

Air is available as an insulating medium and free from special treatment. It has no leakage risk and monitoring demand.

Siemens 3AE vacuum circuit-breakers are maintenance-free within 10,000 times and reach mechanical operations up to 30,000 times. The maintenance-free circuit-breakers and the modular design enable continuous operation without expensive shutdown time. The modular design will also makes the installation easier.

All switchgear types of NXAirS 550+ passed with internal arc classification IAC A FLR, loss of service continuity category LSC2B and partition class PM. All these helps to meet the highest requirements, regarding personal safety.

Typical Applications

NXAirS 550+ air-insulated switchgear is widely applied in the fields which have high requirements for low space-consuming installations, such as data center, marine and harbor, buildings, etc. Its flexible combination with Siemens classical NXAirS Series switchgear can better meet your increasing demands of diversified switchgear typicals and expansibility.

Classification Description

NXAirS 550+ switchgear meet the requirements of IEC 62271-200 and GB 3906

Loss of service continuity category for panel	
Loss of service continuity category	LSC 2B
Partition class	PM (partition of metal)
Accessibility to compartments	
Busbar compartment	Use special tools
Switching device compartment	Comply with interlock control requirements
Connection compartment	Comply with interlock control requirements or use special tools
Internal arcing class	
Comply with the following internal arcing class	
IAC A FLR, I _{sc} , t	
IAC	= Internal arc classification
A	= 300 mm distance of indicators for test (installation in closed electrical service location)
F	= Front arrangement of indicators for test
L	= Lateral arrangement of indicators for test
R	= Rear arrangement of indicators for test
I _{sc}	= Test current for NXAirS 550+ ≤ 12kV, up to 31.5kA
t	= Arc duration 1s

Technical Data

Electrical Data

Technical parameters for NXAirS 550+ air-insulated switchgear (up to)

Technical parameters for NXAirS 550 + air-insulated switchgear	Unit	
Rated voltage	kV	12
Rated frequency	Hz	50
1min. power-frequency withstand voltage (50Hz)	kV	42
Lightning impulse withstand voltage	kV	75
Rated short-circuit breaking current	kA	31.5
Rated short-time withstand current	kA/s	31.5/3 (4)
Rated short-circuit making current	kA	80
Rated peak withstand current	kA	80
Rated normal current of the busbar	A	2,500
Rated normal current of the feeders	A	1,250

Technical parameters of vacuum circuit-breaker (up to)

Model	Unit	3AE
Rated voltage	kV	12
1min power-frequency withstand voltage (50Hz)	kV	42
Lightning impulse withstand voltage	kV	75
Rated operating sequence		O-0.3s-CO-180s-CO
Rated current	A	1250
Rated short-circuit break circuit	kA	31.5
Rated short-time withstand current (up to)	kA/s	31.5/3 (4)
Rated peak withstand current	kA	80
Mechanical life	Times	10,000 (30,000)

Circuit-breaker Panel

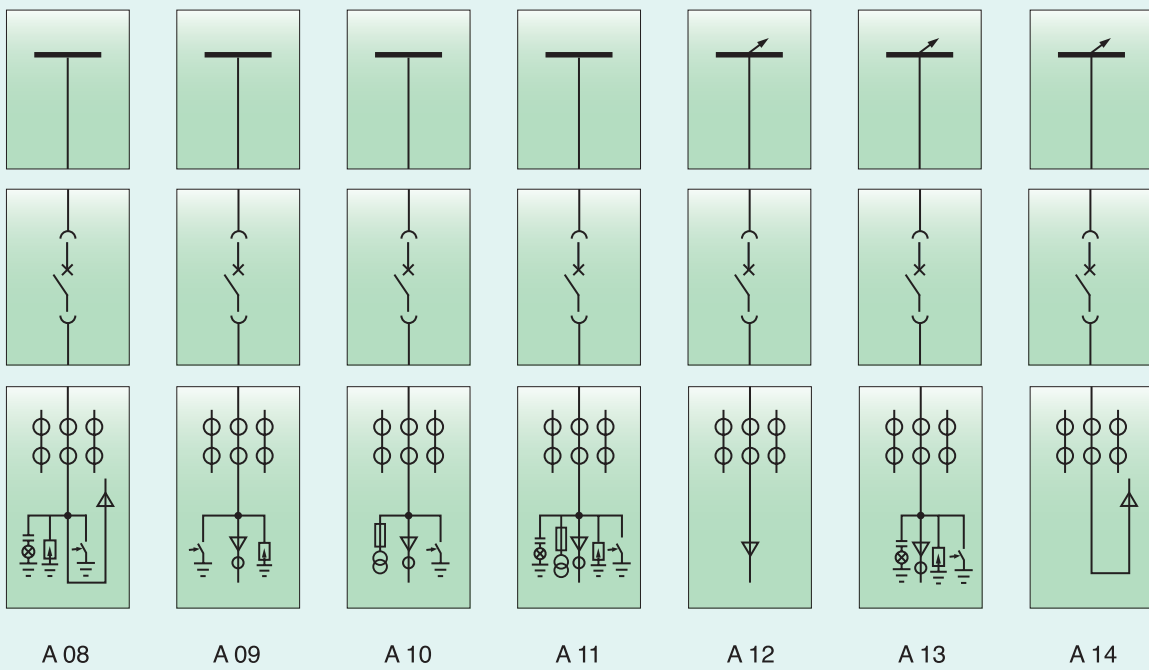
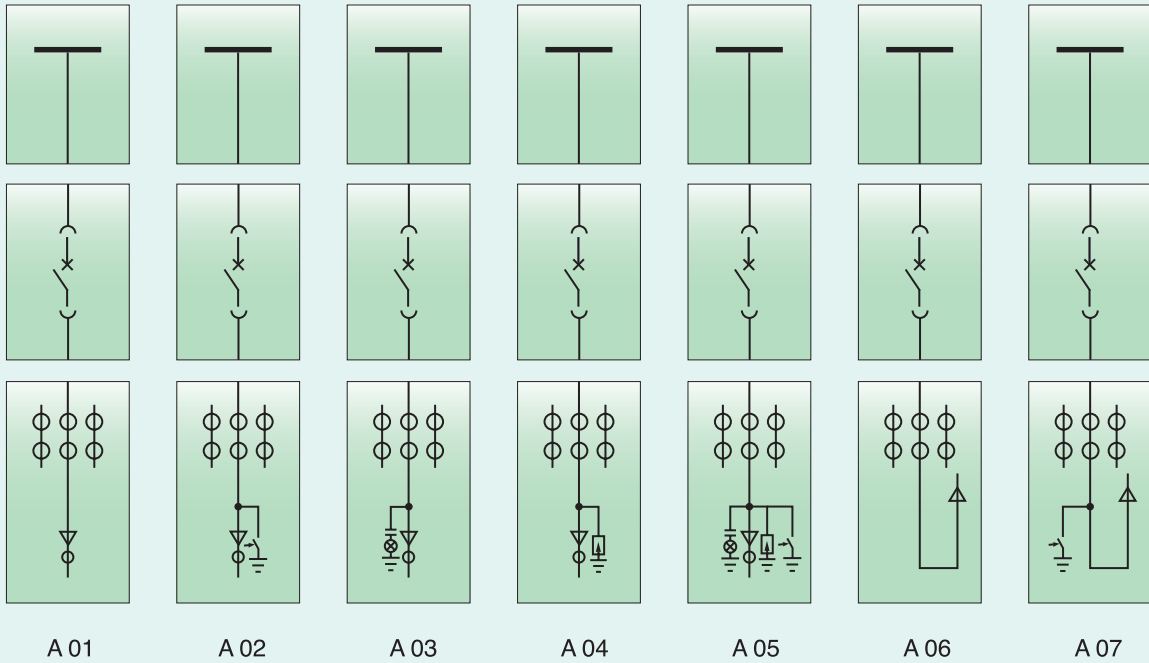

Product Range

Circuit-breaker Panel

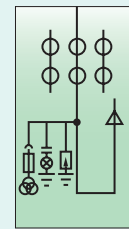
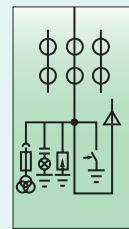
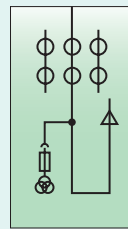
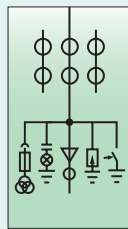
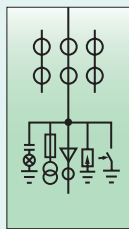
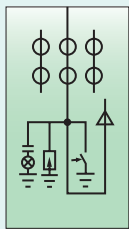
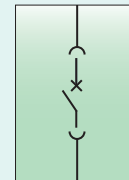
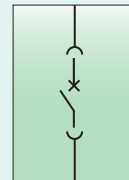
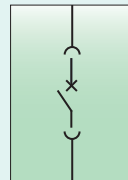
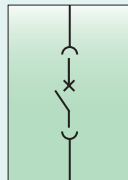
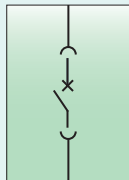
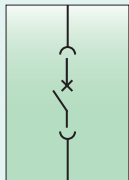
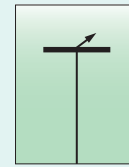
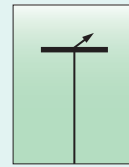
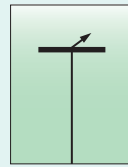
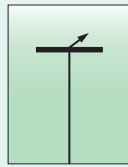
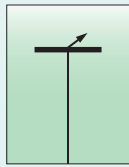
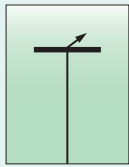

A 15

A 16

A 17

A 18

A 19

A 20

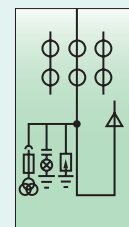
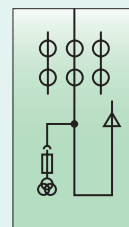
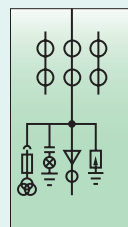
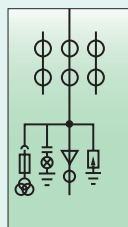
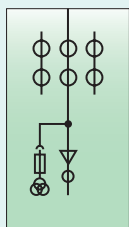
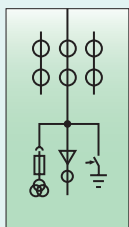
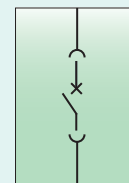
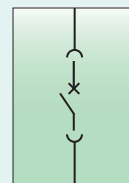
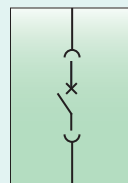
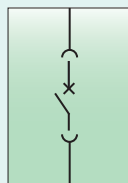
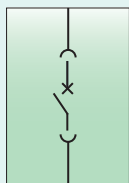
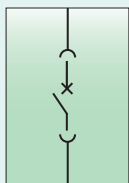
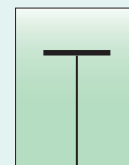
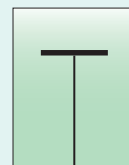
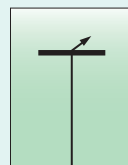
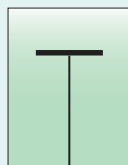
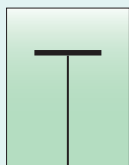
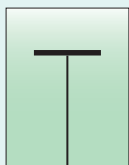

A 21

A 22

A 23

A 24

A 25

A 26

Disconnecting Panel

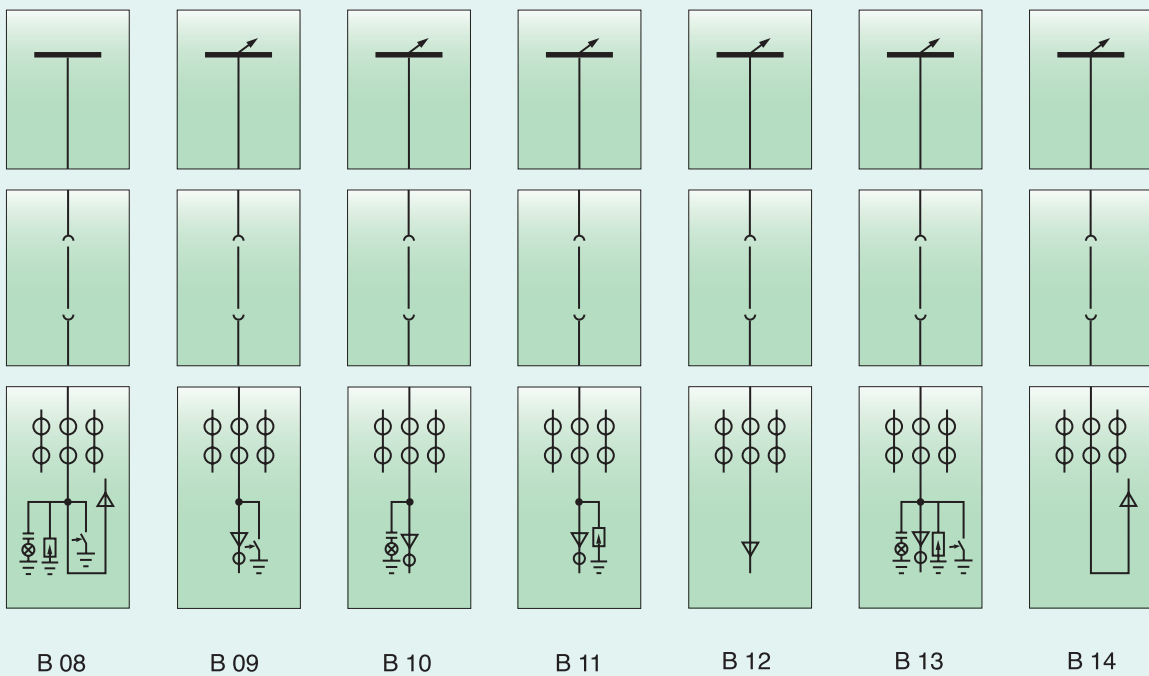
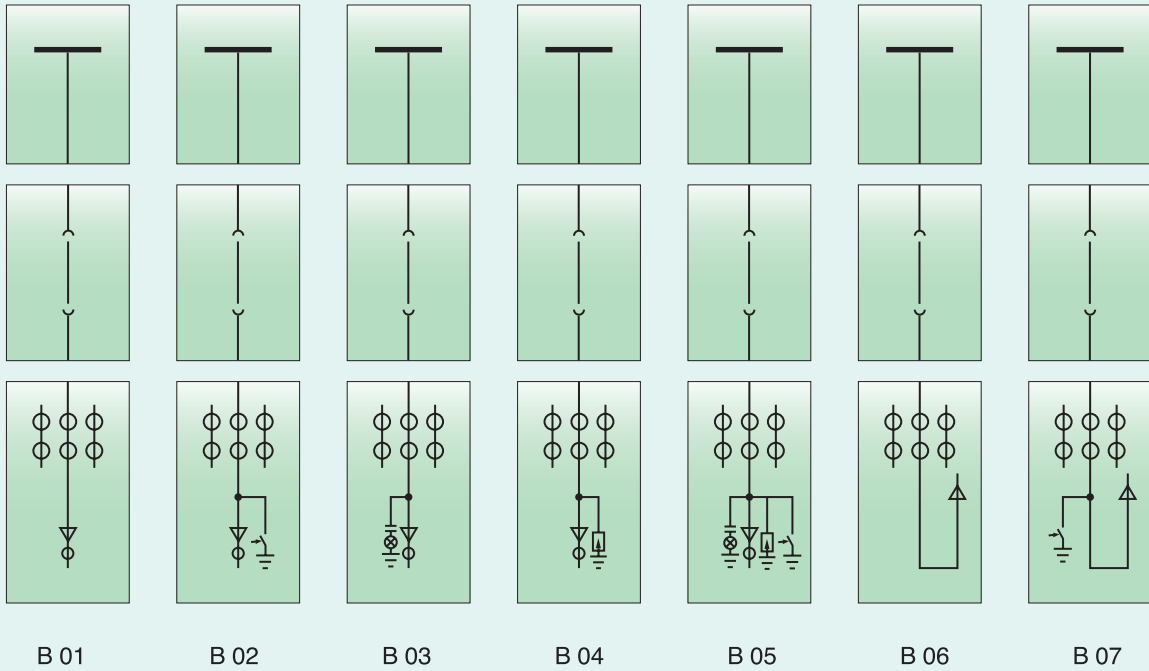

Product Range

Disconnecting Panel

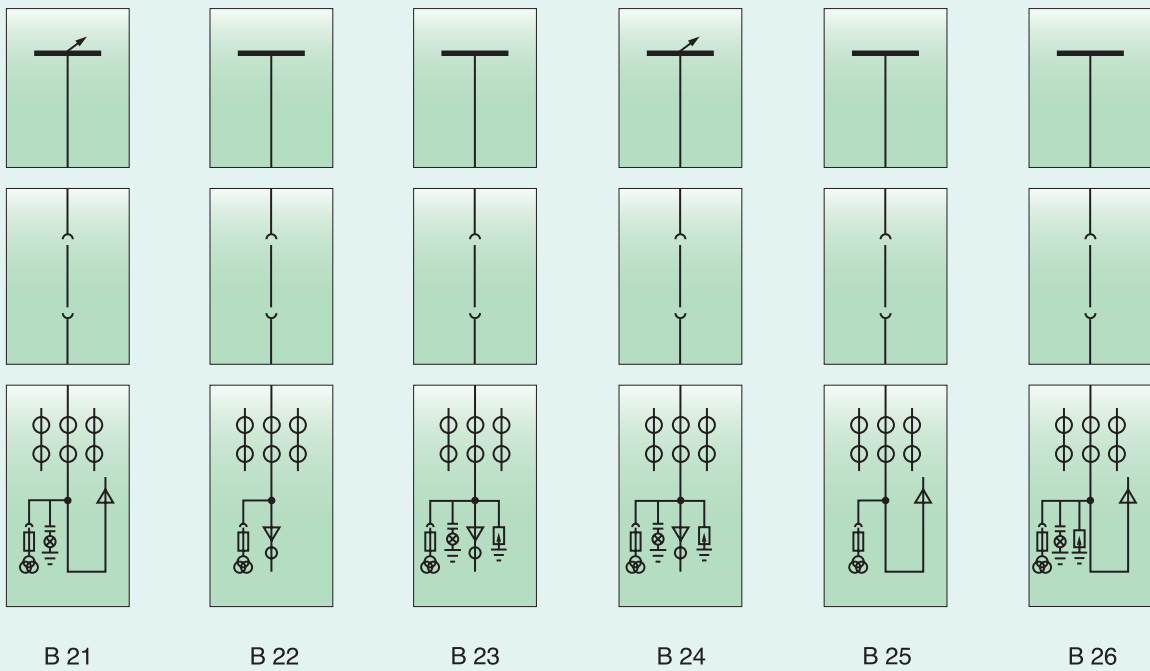
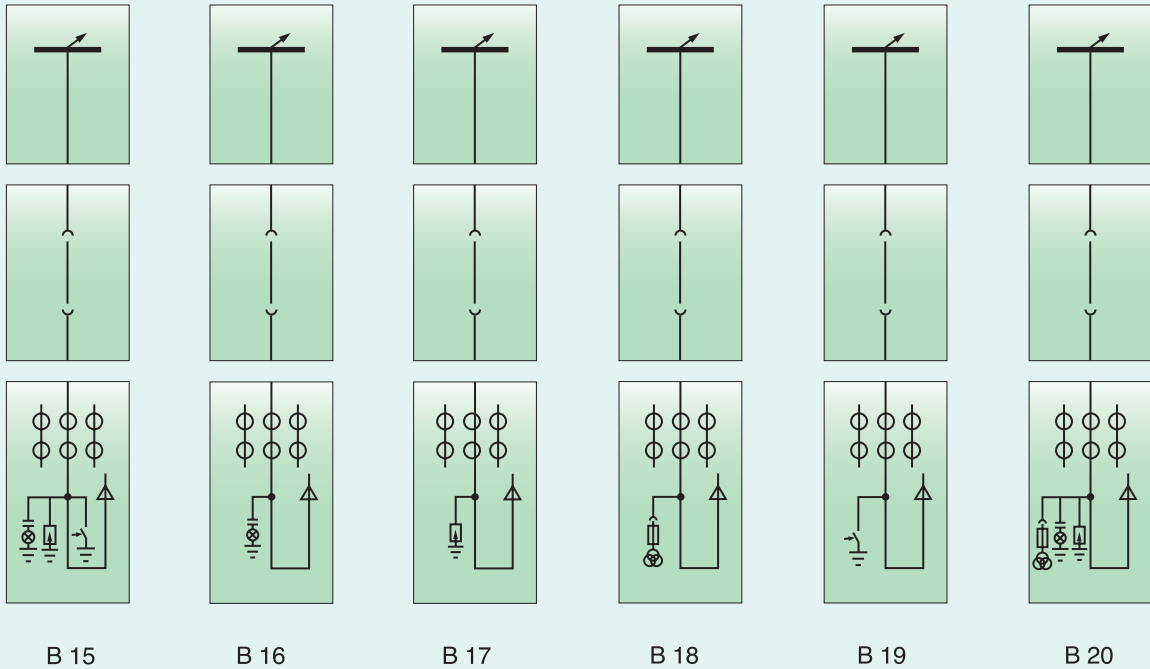

Bus Sectionalizer

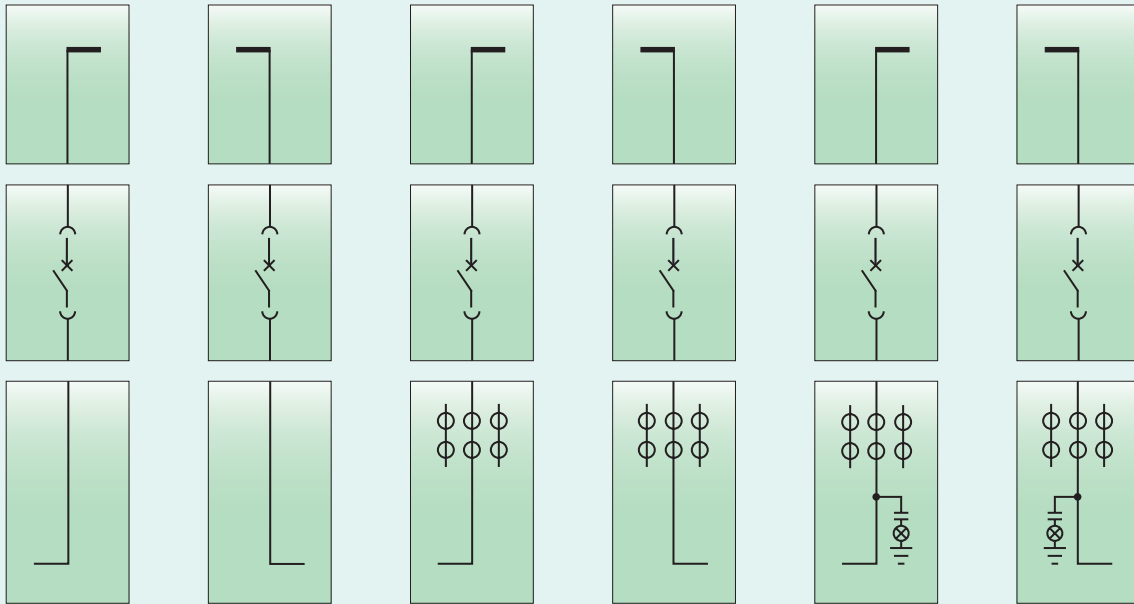

C 01

C 02

C 03

C 04

C 05

C 06

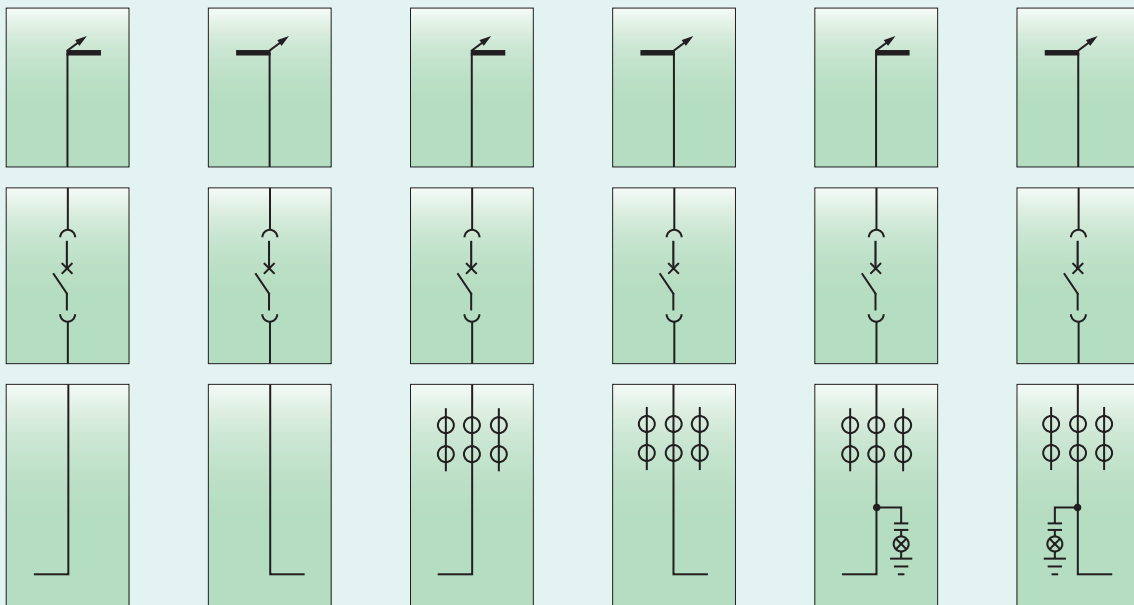

C 07

C 08

C 09

C 10

C 11

C 12

Product Range

Bus Sectionalizer

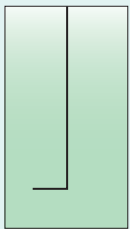
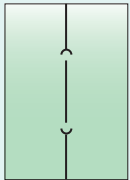
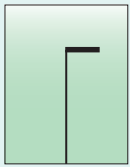

D 01

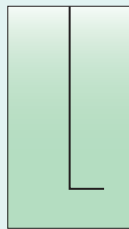
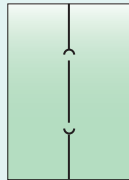
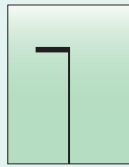

D 02

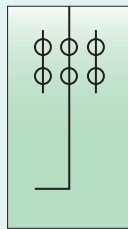
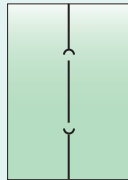
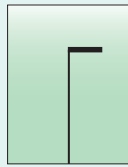

D 03

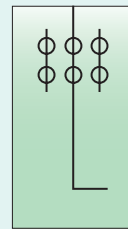
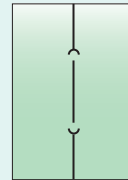
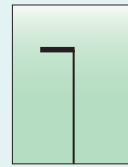

D 04

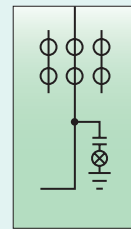
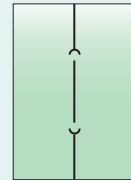
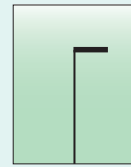

D 05

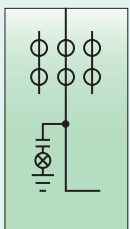
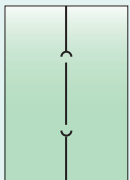
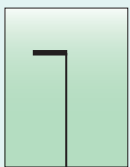

D 06

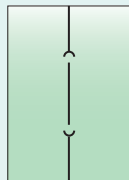
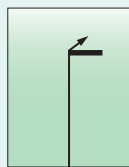

D 07

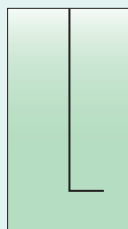
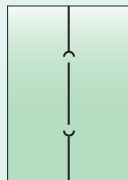
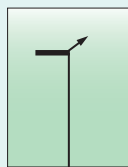

D 08

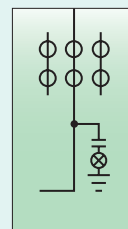
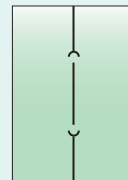
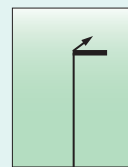

D 09

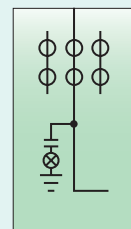
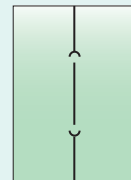
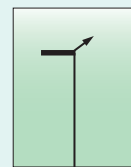

D 10

Voltage Transformer Panel

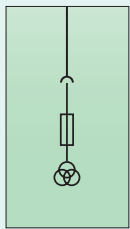
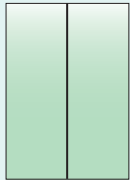
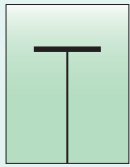

E 01

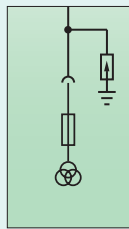
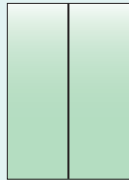
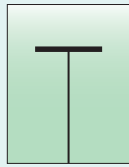

E 02

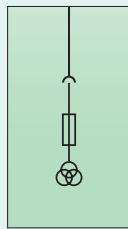
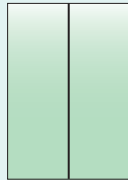
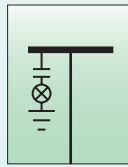

E 03

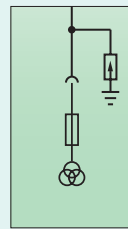
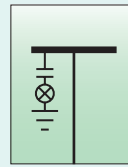

E 04

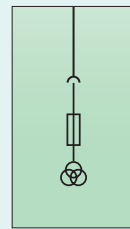
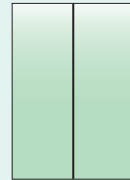
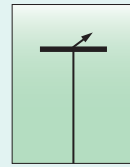

E 05

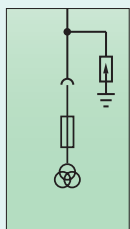
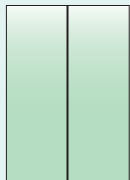
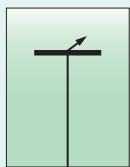

E 06

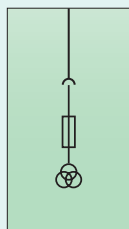
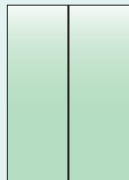
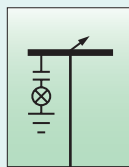

E 07

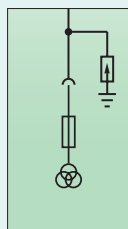
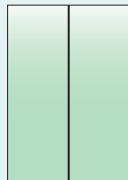
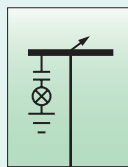

E 08

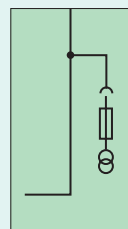
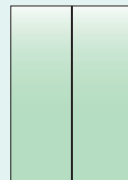
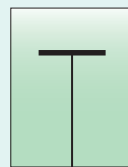

E 09

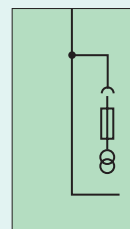
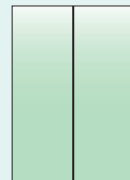
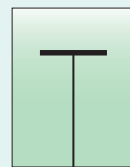

E 10

Product Range

Metering Panel

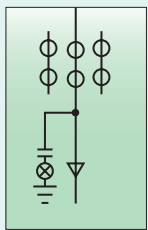
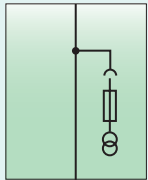
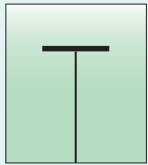

F 01

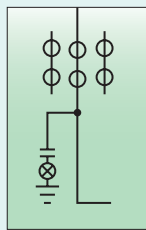
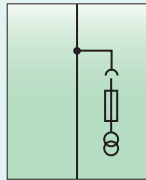
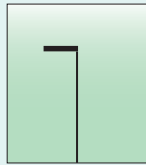

F 02

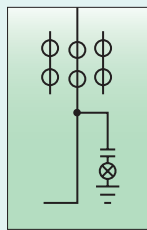
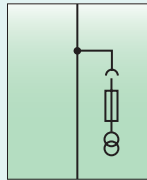
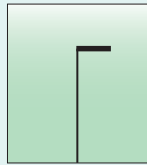

F 03

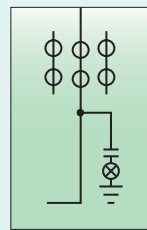
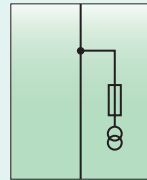
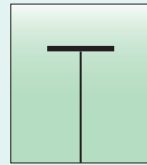

F 04

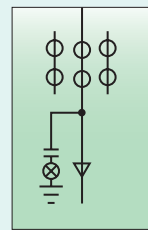
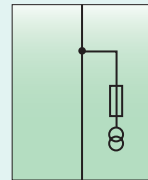
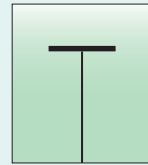

F 05

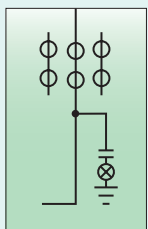
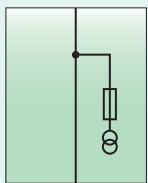
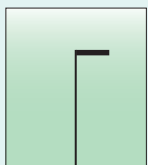

F 06

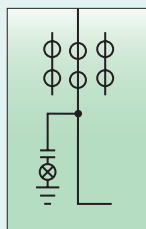
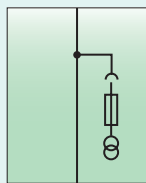
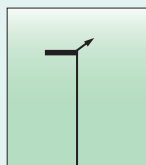

F 07

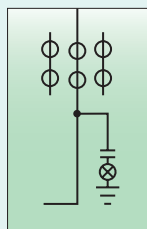
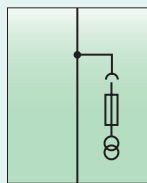
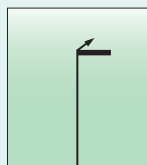

F 08

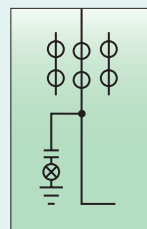
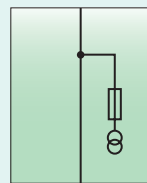
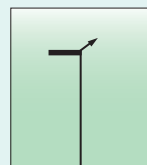

F 09

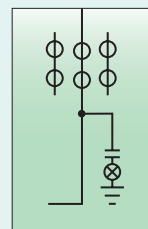
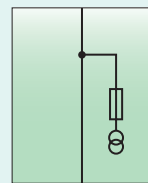
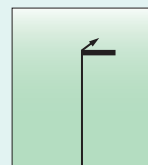

F 10

Self-used Transformer Panel / Symbol Description

Self-used Transformer Panel

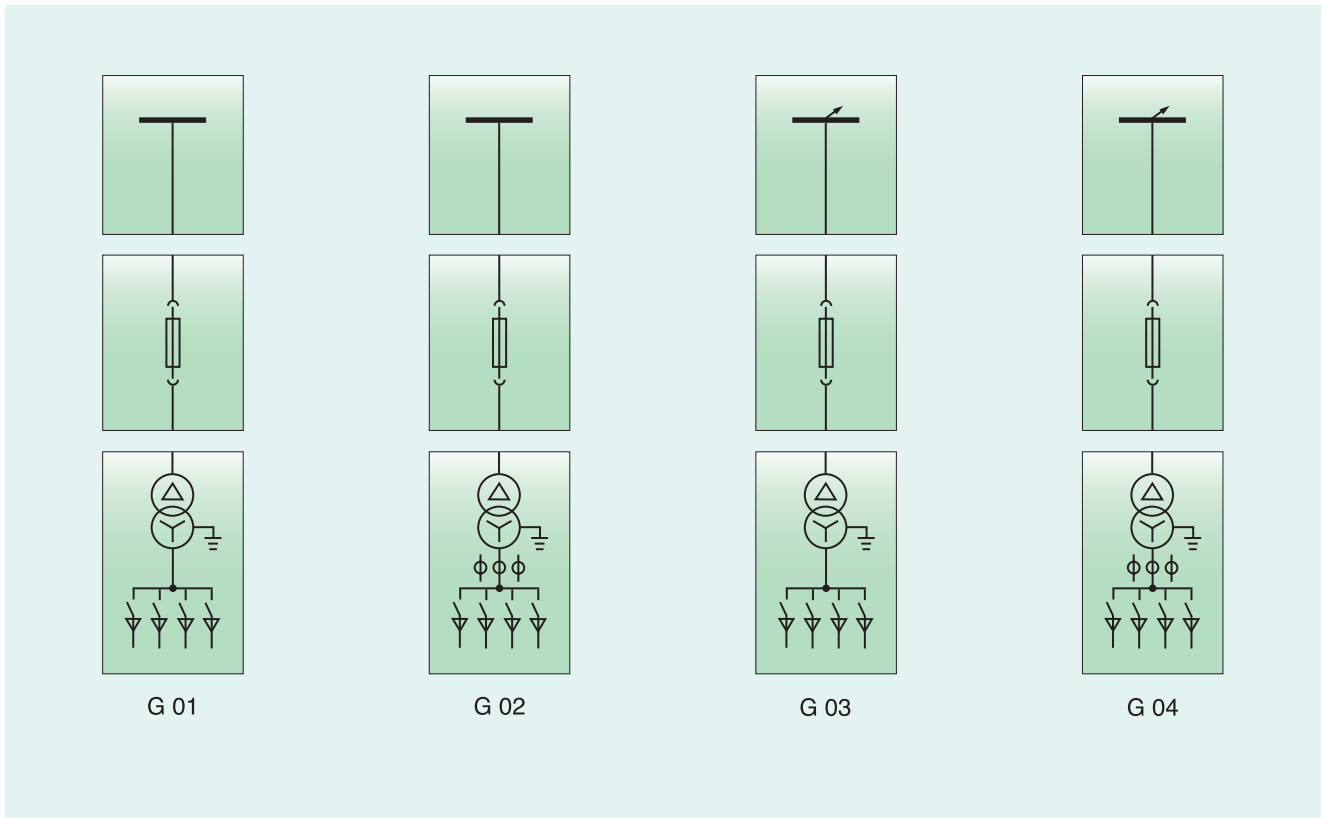

Symbol Description

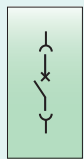

Vacuum Circuit-breaker Truck

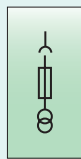

Voltage Transformer Truck (fuse optional)



Disconnecter Link Truck



Top Busbar Connection



Current Transformer

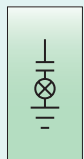

VPIS*

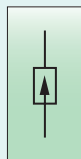

Surge Arrester

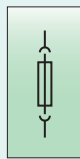

Fuse Truck

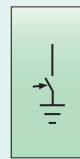

Make-proof Earthing Switch



Auxiliary Transformer

* VPIS: Voltage Presence Indicating System

Design

Basic Design of Switchgear

Features

- Integrated mimic diagram.
- Display of the respective switch positions for circuit-breaker CLOSED/OPEN, disconnected position, earthing switch CLOSED/ OPEN, on the integrated mimic diagram.
- Unambiguous assignment of actuating openings and control elements to the corresponding position indicators.
- All switching operations are always with high-voltage door closed.
- Ergonomically favorable height for all control and indicator elements.
- Options: Verification of safe isolation from supply for feeder or busbar by means of the capacitive voltage detecting system with panel front closed.

Interlocks

- Interlock conditions specified according to IEC 62271-200/ GB3906 are fulfilled.
- Earthing switch can only be operated with switching device in disconnected position.
- Switching device can only be racked on the movable part with the associated switching device OPEN position and with earthing switch OPEN.

Option: Electromagnetic interlock, mechanical key interlocking system

Switchgear Structure (as illustrated)

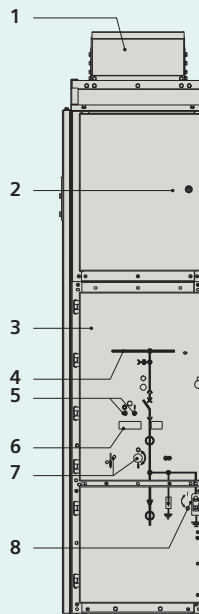

- 1 Pressure relief duct, if required with top-mounted arc absorber
- 2 Door to low voltage compartment
- 3 Door to high voltage compartment
- 4 Mimic Diagram
- 5 "CLOSE-OPEN" actuating openings for the circuit-breaker, opening for spring charging
- 6 Inspection window to recognize the "CLOSED-OPEN" indicator of the circuit-breaker, "closing spring charged" indicator, operations counter
- 7 Actuating opening for switching device, manual operation
- 8 Mechanical position indicator and actuating opening for earthing switch, manual operation

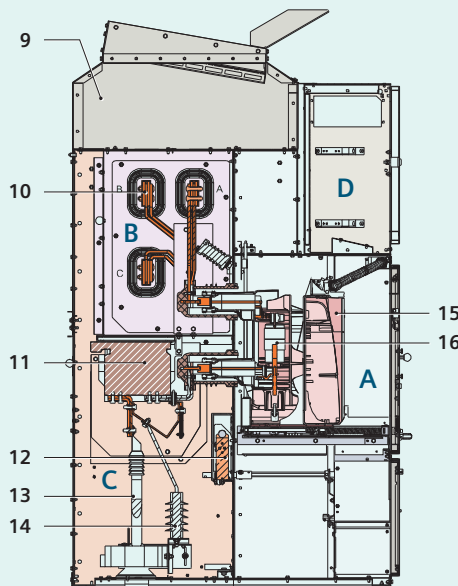

- A Switching-device compartment
- B Busbar compartment
- C Connection compartment
- D Low-voltage compartment
- 9 Pressure relief duct, if required with top-mounted arc absorber
- 10 Busbar
- 11 Block-type current transformer
- 12 Earthing switch
- 13 Cable
- 14 Surge Arrester
- 15 Withdrawable vacuum circuit-breaker
- 16 Vacuum Interruptors

Switchgear Design Introduction

NXAirS 550+ air-insulated compact switchgear

The frame is made of high-strength corrosion-resistant Al-Zn-plated steel plate and we take its design of safety and convenient installation into consideration. Each switchgear comprises a switching device, a busbar compartment, a connection compartment and a low-voltage compartment. Each compartment provides a pressure relief channel whose metallic lid can be opened automatically. If internal arcing fault occurs, the channel can release arcing pressure immediately, which can guarantee operators' personal safety.

Switching Device Compartment

- Shutter mechanism in the switching device compartment is such arranged to easily open and close the busbar compartment and connection compartment. It can be opened and closed automatically with the moving of switching device.
- It is equipped with metal cable wireway on the left, which used for paving control line so as to take effective use of the space in the cabinet. In this way, we make the internal compartment neater and metallic cover the LV wires.
- Depending on the typical, it is possible to arrange vacuum circuit-breaker, disconnecting or metering unit.

Low-voltage plug connector for connection of control cables between primary part and secondary part. Only when at the test position, can the circuit-breaker be plugged into or out of secondary plug. The interlock is installed between the secondary plug and circuit-breaker. It can ensure the high-voltage door closed only when the plug is well-plugged.



Low-voltage Compartment

- Low-voltage compartment can be customized according to customers' requirements and is internally equipped with various protection, control, measurement and metering equipment.
- Low-voltage compartment is 705mm high. and it can achieve the height of max. 980mm according to the requirements.
- Low-voltage compartment is arranged such to be ergonomic, suitable in height and convenient for operation and observation.
- Lines are encoded by laser printing. They can be arranged appropriately and the encoded ones are convenient for on-site checking.

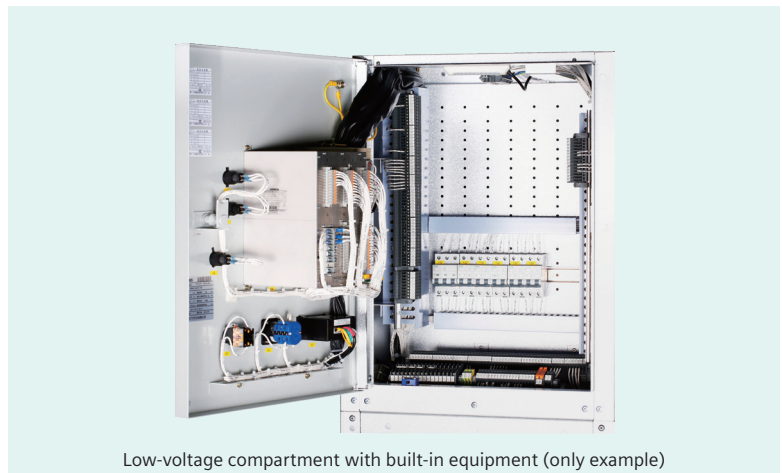

Low-voltage compartment with built-in equipment (only example)

Design

Compartment introduction

Busbar compartment

- Enclosure made of Al-Zn-plated sheet steel.
- Pressure relief upwards.
- Busbar adopts conventional "top and twin-side bottom" structure of NXAirS switchgear to save the vertical space. The same structure and position of the busbar enables easy combine with other different NXAirS series panel.
- Siemens use flat copper, bolted from panel to panel. The bolt hole is rhombic design and convenient for construction personnel's site installation .



Connection Compartments

- Enclosure made of Al-Zn-plated sheet steel.
- Pressure relief upwards through rear pressure relief duct.
- The connection compartment, with large space therein, can connect multiple cables; the cable connection height is high enough to make the installation easier.
- We can provide both cable-in options from the bottom and the top as customers requirement.
- According to customer requirements, components like CT, PT and make-proof earthing switch can be installed.
- We recommend LZZBJ9-12/150b/2 as CT, JDZXR-10X (3PTs) as PT or JSZVR2-10C1 (2PTs).



Switchgear Components Introduction

3AE Vacuum Circuit-breaker

- Siemens has more than 30-year-experience of vacuum products design and operating.
- It is maintenance-free for more than 10000 times and reaches a mechanical life up to 30,000 times under normal conditions with maintenance.
- The contact of vacuum interrupt adopts Cu-Cr alloy and has high dielectric strength, high short-circuit breaking, strong arc erosion resistance capability and very low contact resistance.
- Highly flame-retardant insulating materials are used and all organic material parts meet the requirements for Grade V0 self arc extinguishing stipulated according to UL standard.

**SIPROTEC 4 Series****SIPROTEC 4 7SJ62 multifunction protection relay**

It is a microcomputer integrated protection measuring and control device, which provides a human machine interface. Its parameter can be input via panel keyboard in order to facilitate the practical operation.

- Overcurrent and zero sequence overcurrent protection with or without directions
- Under frequency and over frequency protection
- Under voltage and over voltage protection
- Reclosure function
- Programmable CFC function
- IEC 60870-5-103, Modbus or IEC 61850 communication protocol (GOOSE message)
- Two optional ports: RS485 port and Ethernet port
- Front USB port: convenient for remote maintenance and fault diagnosis

More models will be provided for various demands



Dimension & Layout

Foundation Dimension

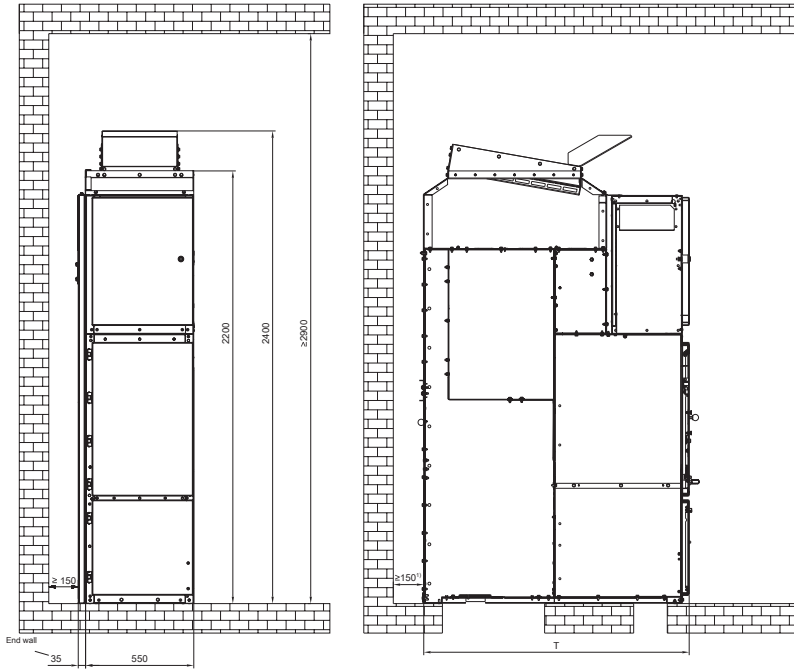

T: Panel Depth (mm)

A	Standard panel	1350
B	Panel with busbar riser in busbar compartment	1480
C	Panel with standard rear duct 460 mm	1810

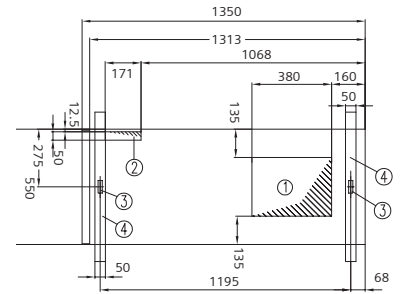

A

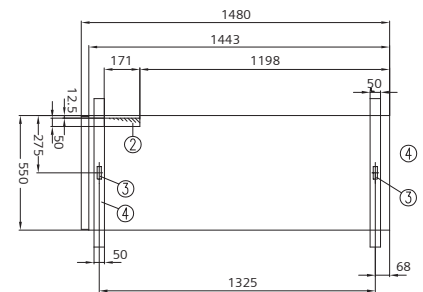

B

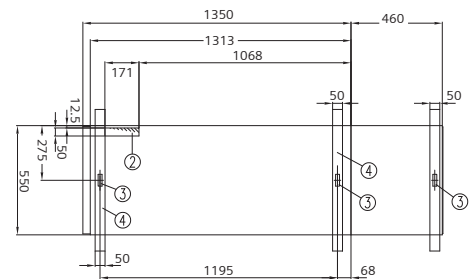

C

- ① Cable Position (Depends on whether cable is used or not)
- ② Control Cable Position
- ③ Fixed Point, 20 × 60mm rectangular hole
- ④ Install 5# U-bar in front and rear of the switchgear

Switchgear Assembling Layout

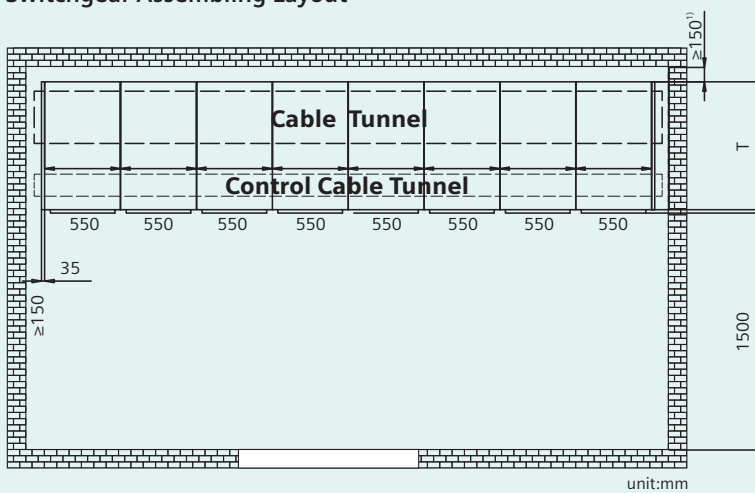

¹⁾ For connection from the front ≥150mm (only when PT is not in the cable compartment applicable)
For connection from the rear ≥ 1000mm

Applicable Standards and Applicable Environment

Applicable Standards

Switchgears comply with corresponding standards and specifications.

Standard Overview

		IEC standards	GB standards
Switchgear	NXAirS	IEC 62271-1	GB/T 11022
		IEC 62271-200	GB 3906
Device	Vacuum circuit-breaker	IEC 62271-100	GB 1984
	Disconnecting and earthing switch	IEC 62271-102	GB 1985
	High-voltage fuse	IEC 60282	GB 15166.2
	Voltage detecting systems	IEC 61243-5	
Degree of protection	-	IEC 60529	GB/T 4208
Insulation	-	IEC 60071	GB 311.1
Instrument transformer	Current transformer	IEC 60044-1	GB 1208
	Voltage transformer	IEC 60044-2	GB 1207
Installation	-	IEC 61936-1	GB50254, GB50259

Applicable Environment

1. Ambient air temperature: $-15^{\circ}\text{C} \sim +40^{\circ}\text{C}$;
2. Relative humidity: daily mean $\leq 95\%$; monthly mean $\leq 90\%$.
3. Altitude: $\leq 1,000\text{m}$;
4. Seismic intensity: $\leq \text{VIII}$;
5. Environment without fire hazard, explosion hazard or severe contamination, chemical corrosion and violent vibration.
Where applicable environment exceeds above-mentioned range, users need negotiate with Siemens for permissible range and technical measures.

Altitude correction factor K_a

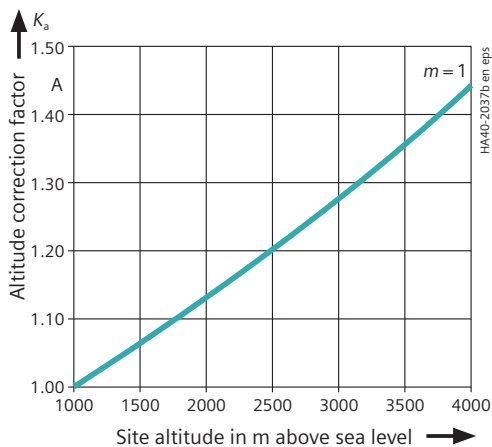

For site altitudes above 1000 m, the altitude correction factor K_a is recommended, depending on the site altitude above sea level.

Rated short-duration power-frequency withstand voltage to be selected for site altitudes $> 1000 \text{ m}$

\geq Rated short-duration power-frequency withstand voltage up to $\leq 1000 \text{ m} \cdot K_a$

Rated lightning impulse withstand voltage to be selected for site altitudes $> 1000 \text{ m}$

\geq Rated lightning impulse withstand voltage up to $\leq 1000 \text{ m} \cdot K_a$

Example:

2000 m site altitude above sea level,

12 kV switchgear rated voltage,

75 kV rated lightning impulse withstand voltage,

Rated lightning impulse withstand voltage to be selected $= 75 \text{ kV} \cdot 1.14 = 85.5 \text{ kV}$

Result

According to the above table, a switchgear for a rated voltage 12kV with a rated lightning impulse withstand voltage of 86kV is to be selected.

**Published by
Siemens Ltd., China**

Siemens AG
Smart Infrastructure
Distribution Systems
Mozartstraße 31 C
91052 Erlangen
Germany

Siemens Ltd., China
Smart Infrastructure
Distribution Systems
299, Tianning Road, Min Hang District
200245 SHANGHAI, China

Siemens Switchgear Limited Shanghai
298, Tianning Road, Min Hang District
200245 SHANGHAI, China

For further information please contact
Our Customer Support Center
Phone: +49 180 524 7000
Fax: +49 180 524 2471

Order No.: EMMS-B80049-00-5DCN
1797-S906573-0719.5

Subject to changes and errors. The information given in this document only contains general descriptions and/or performance features which may not always specifically reflect those described, or which may undergo modification in the course of further development of the products. The requested performance features are binding only when they are expressly agreed upon in the concluded contract.

NXAirS and SION are registered trademarks of Siemens AG. Any unauthorized use is prohibited. All other designations in this document may represent trademarks whose use by third parties for their own purposes may violate the proprietary rights of the owner.

Scan the QR code to
know more about
information of
Distribution Systems

